

Installation and Operation Manual



Note: Please read all the instructions carefully before installing this product.

3 Series Back-to-Back Half Rack

22-0532 | 22-0560

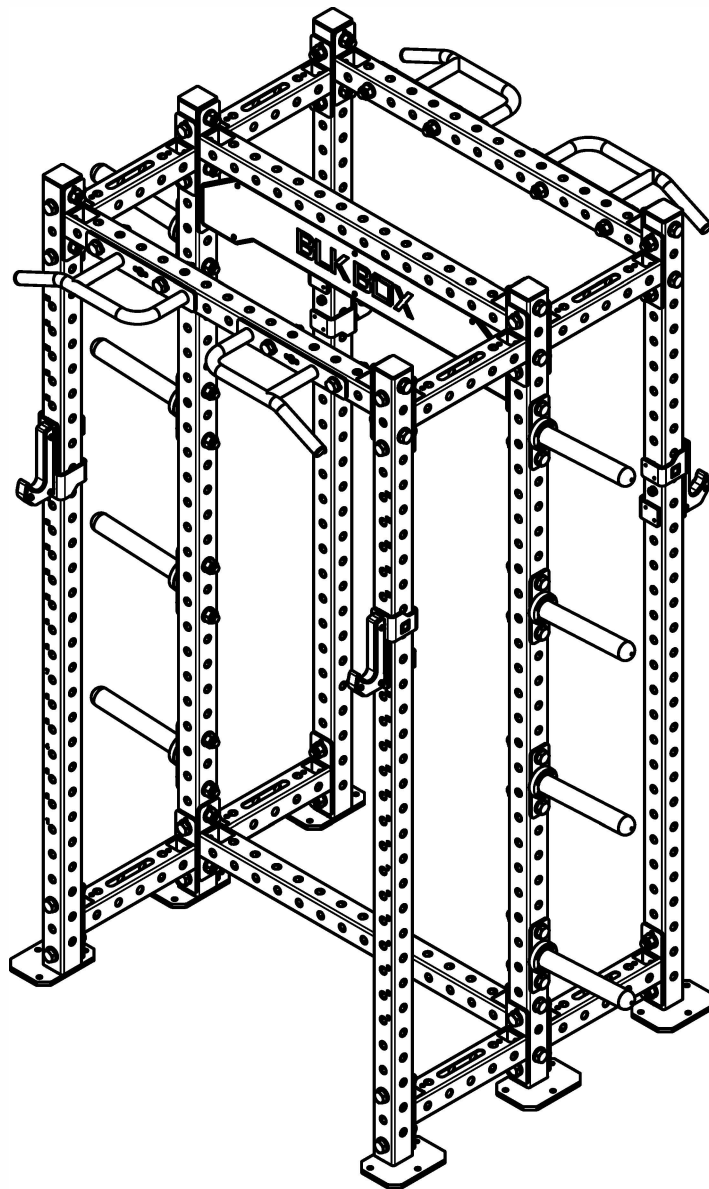

January 2026 | Version 1.0 | © BLK BOX Fitness Ltd. 2026

Product Specification

Specification Table

Max. User Weight	120 kg
Max. Training Weight	300 kg
Product Weight for 2.4m	222 kg
Product Weight for 2.2m	210 kg
Overall "Static" Dimensions (L x W x H) for 2.4m	1385 mm x 1865 mm x 2385 mm
Overall "Static" Dimensions (L x W x H) for 2.2m	1385 mm x 865 mm x 2185 mm
Overall "In-Use" Dimensions (L x W x H) for 2.4m	2885 mm x 3365 mm x 2385 mm
Overall "In-Use" Dimensions (L x W x H) for 2.2m	2885 mm x 3365 mm x 2185 mm
Utility Peg Diameter	48.3mm
Utility Peg Max. Load	125 kg

Training Area

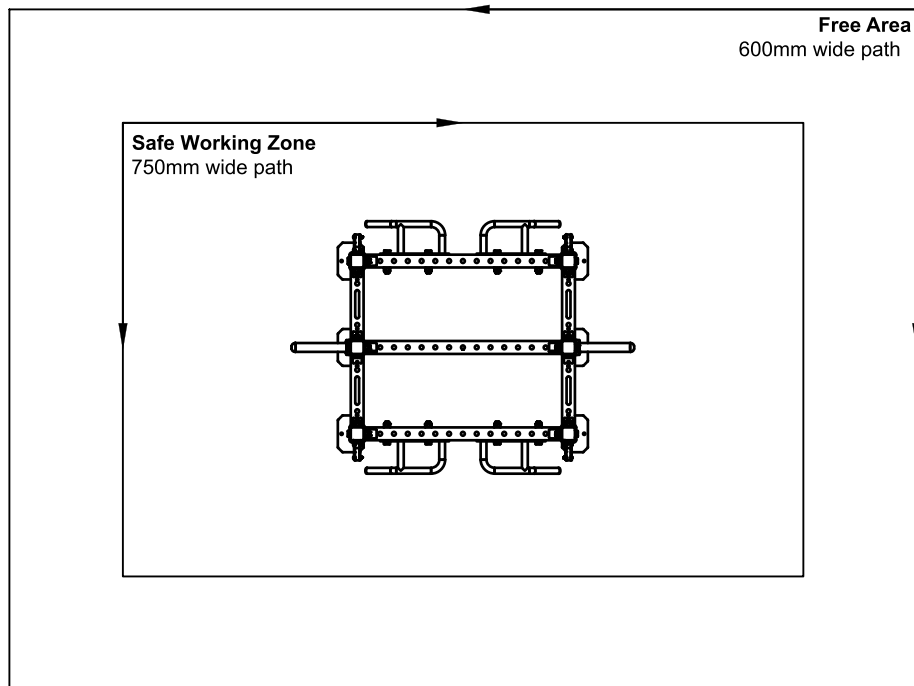

The designated **free area** must extend at least **600mm** beyond the **safe working zone** on all sides. This space is intended to allow users to dismount safely and without obstruction in the event of an emergency. The **safe working zone** is defined as a **750mm** clear path surrounding the equipment rack. Where two pieces of equipment are placed adjacent to one another, the free area may be shared, provided all safety and access requirements are maintained. It is the responsibility of the installer and facility operator to ensure that all spacing requirements are met in accordance with this guideline.

Warning

Serious or fatal injuries may occur from incorrectly assembled equipment or improper use of tools. Always ensure bolts are tightened correctly and all parts are level and plumb. To further reduce risk of injuries, please use our suggested tools and personal protective equipment (PPE). We suggest that a minimum of three people are involved in the assembly of this product. Each person should be equipped with safety glasses, steel toe cap boots and ear plugs.



This symbol is an indication of the recommended minimum torque each bolt should be tightened to. This value will be dependent on the bolt type. Please hand tighten all bolts until you see this symbol.

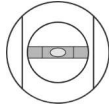

Please be aware of this symbol as an indication to check that the part is level and/or plumb.

Tools Required

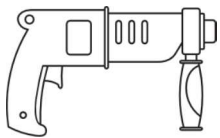

Hammer Drill

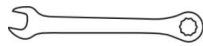

30mm Spanner x2



13mm Spanner



Hammer

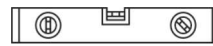

Spirit Level



10mm Masonry Drill Bit



Step Ladder



Vacuum

Parts List

#	Item Description	Qty.
A	3 Series Numbered Upright - LHS	2
B	3 Series Numbered Upright - RHS	2
C	3 Series Plain Upright	2
D	3 Series 0.4 Box CM	8
E	3 Series 1.2 Double Branding Box	1
F	3 Series 1.2 Box CM (Simple)	3
G	Utility Peg	8 / 6
H	Knurled Multigrip - Pair	2
I	3 Series Sandwich J-Hook - Pair	2
J	M20×110 Hex Head Bolt	64
K	M20 Washer	128
L	M20 Nyloc Nut	64
M	M10 Sleeve Anchor Bolt	18
N	M 10 Washer	36

Parts

A

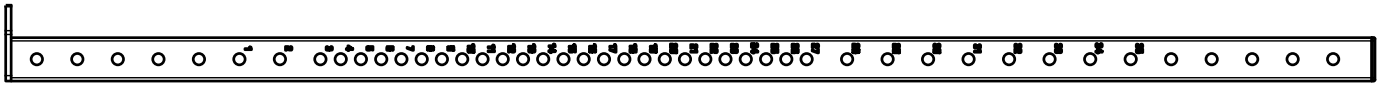

B

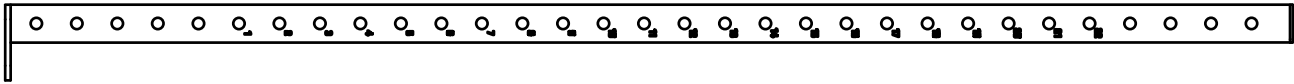

C

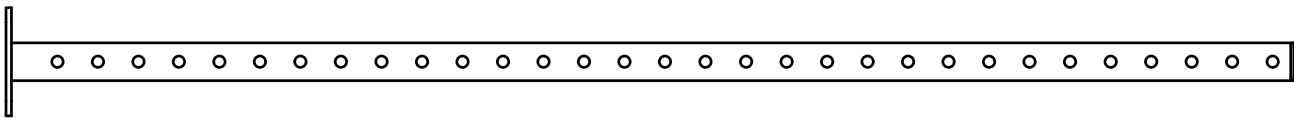

D

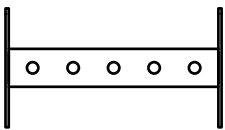

E

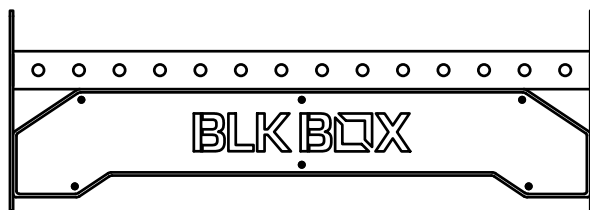

F

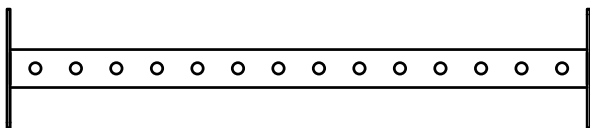

G

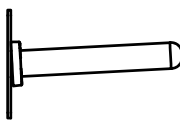

H

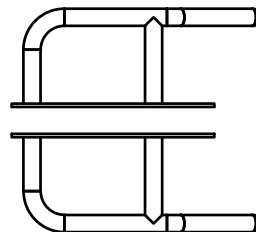

I

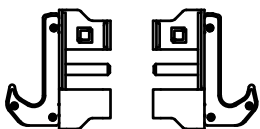

J



K



L



M

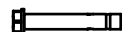

N



Components highlighted with an orange box indicate areas that are more susceptible to wear and tear during use.

Hardware 1:1 Scale

M10x80 Sleeve Anchor Bolt

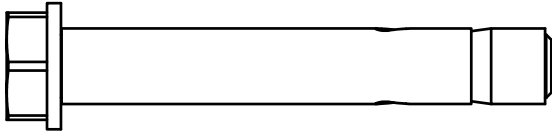

M20x120 Hex Head Bolt

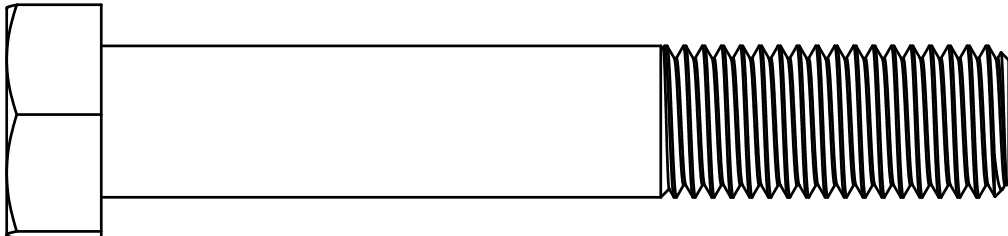

M10 Washer

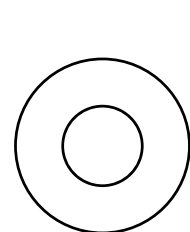

M20 Washer

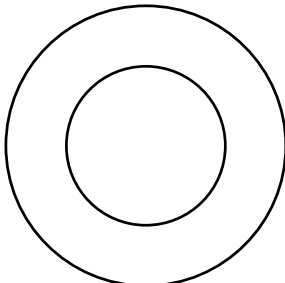

M20 Nut

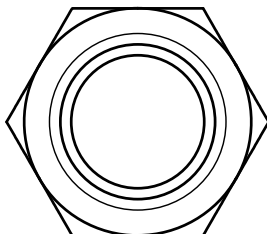

Assembly

1

Parts	
#	Qty.
A	2
B	2
C	2
D	8

Hardware	
#	Qty.
J	24
K	48
L	24

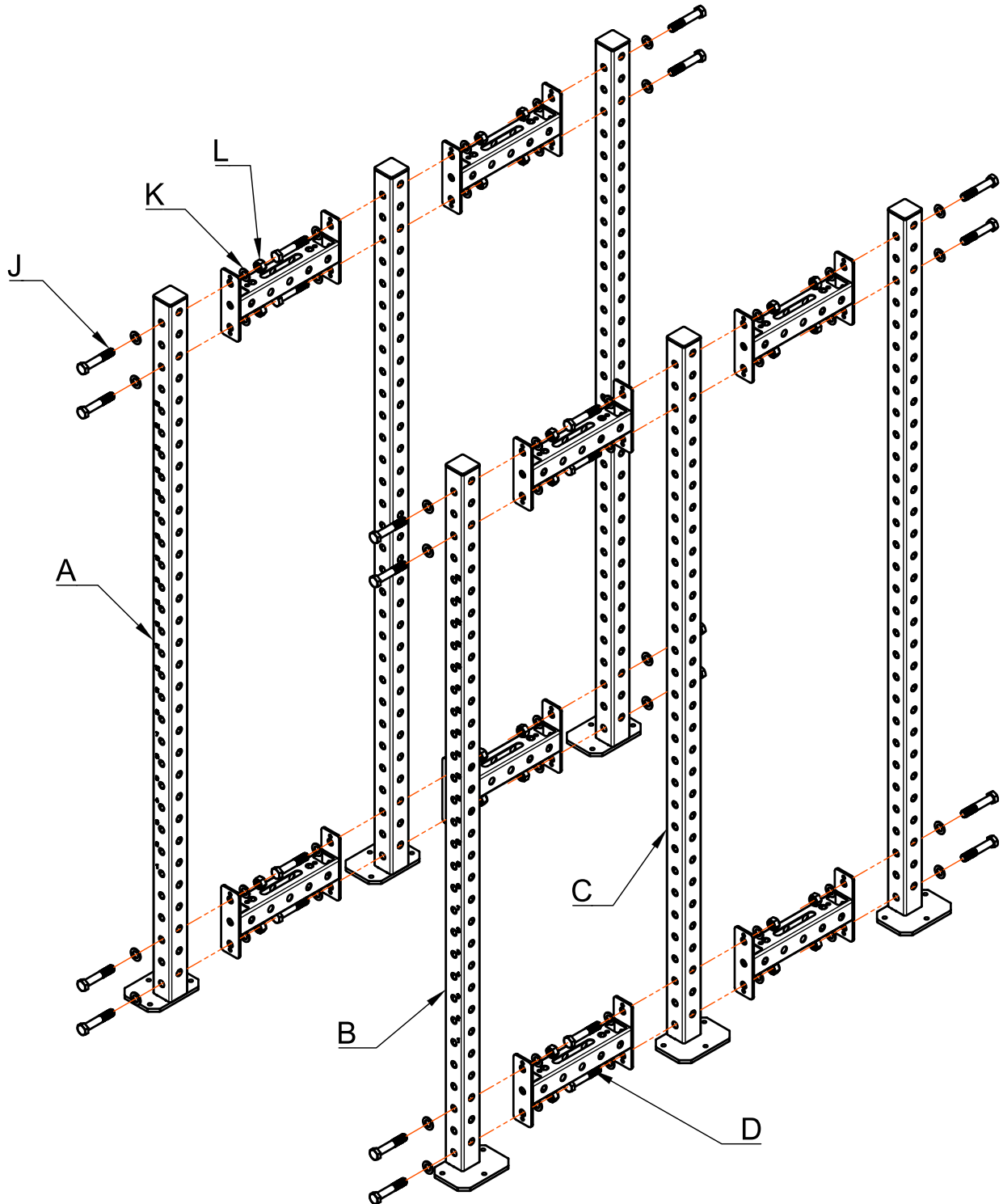

30mm Spanner x2

Assembly

2

Parts	
#	Qty.
E	1
F	3

Hardware	
#	Qty.
J	16
K	32
L	16

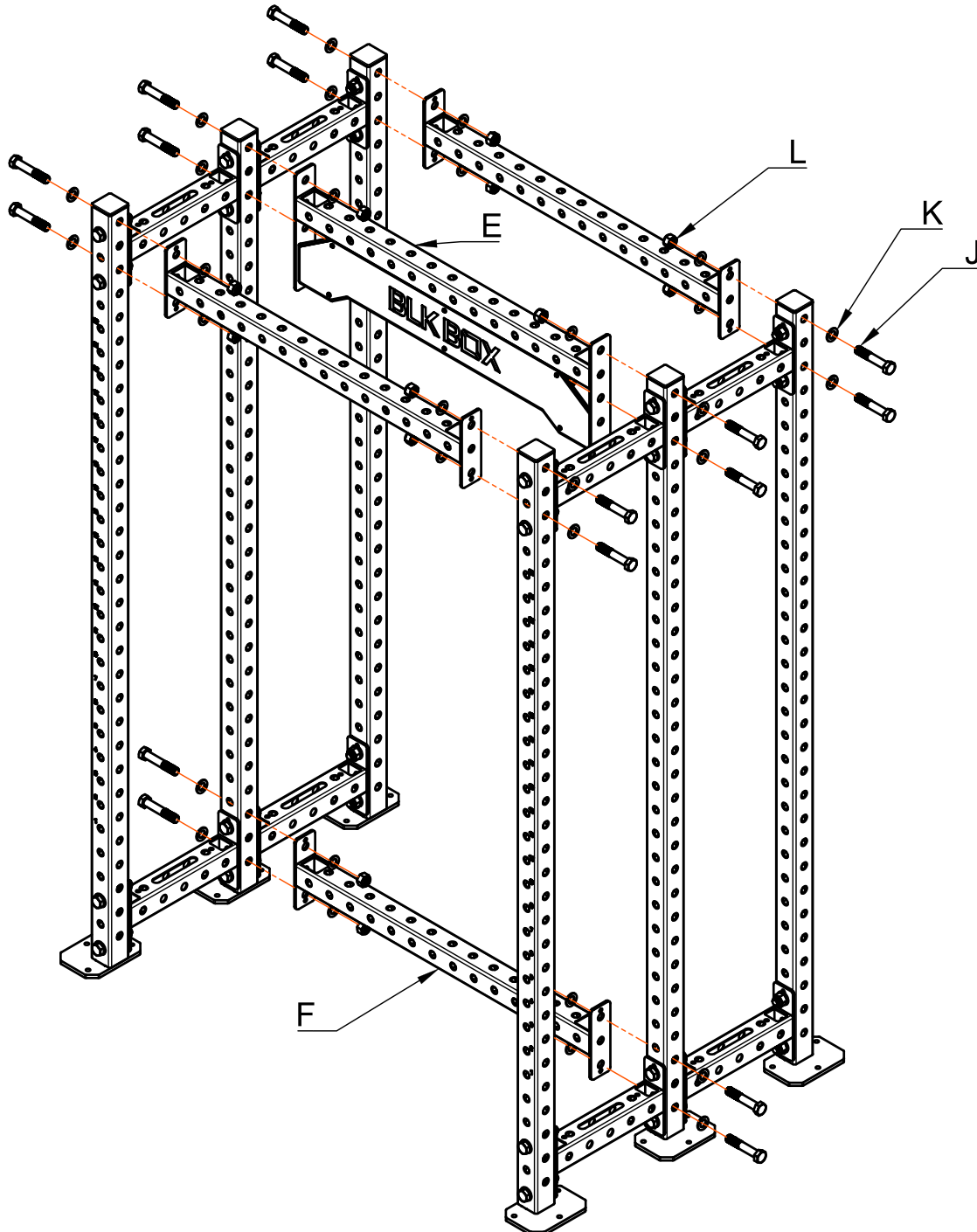

30mm Spanner x2

Assembly

3

Parts	
#	Qty.
G	8

Hardware	
#	Qty.
J	16
K	32
L	16

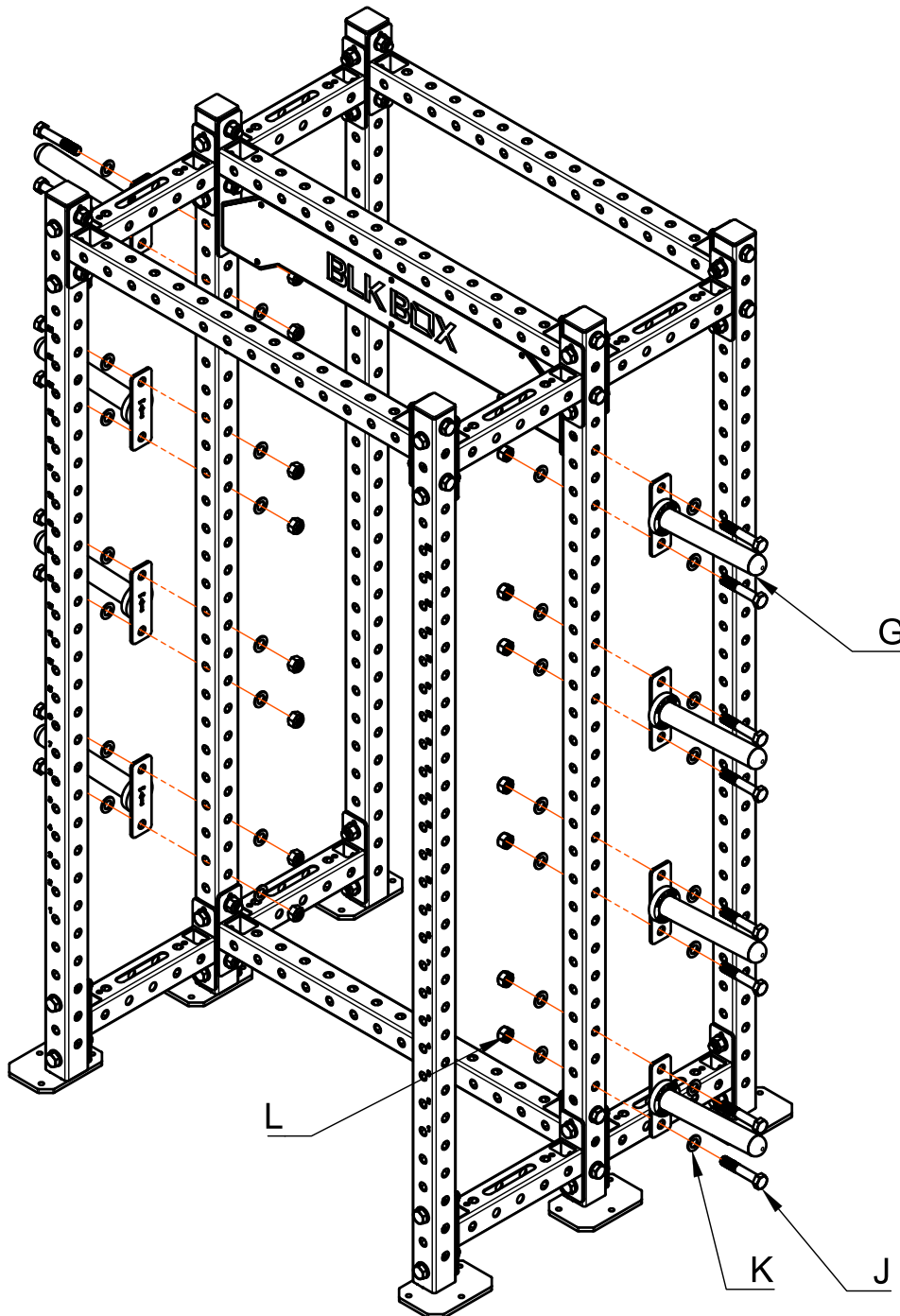

30mm Spanner x2

Assembly

4

Parts	
#	Qty.
H	2

Hardware	
#	Qty.
J	8
K	16
L	8

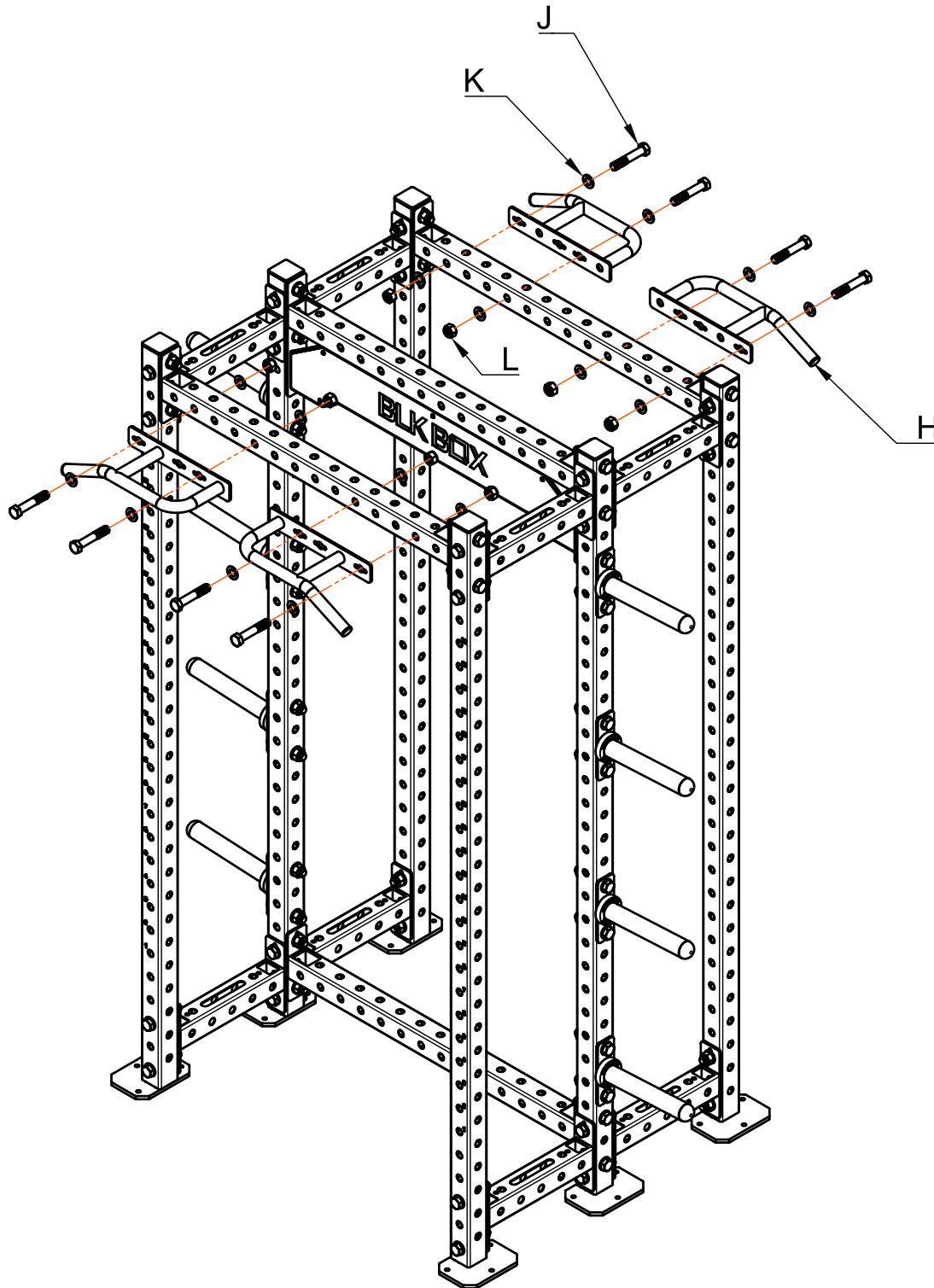

30mm Spanner x2

Assembly

5

25
Nm

Position the rack in the desired location and tighten all bolts to the specified torque.

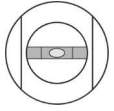

Ensure all components are level and plumb.

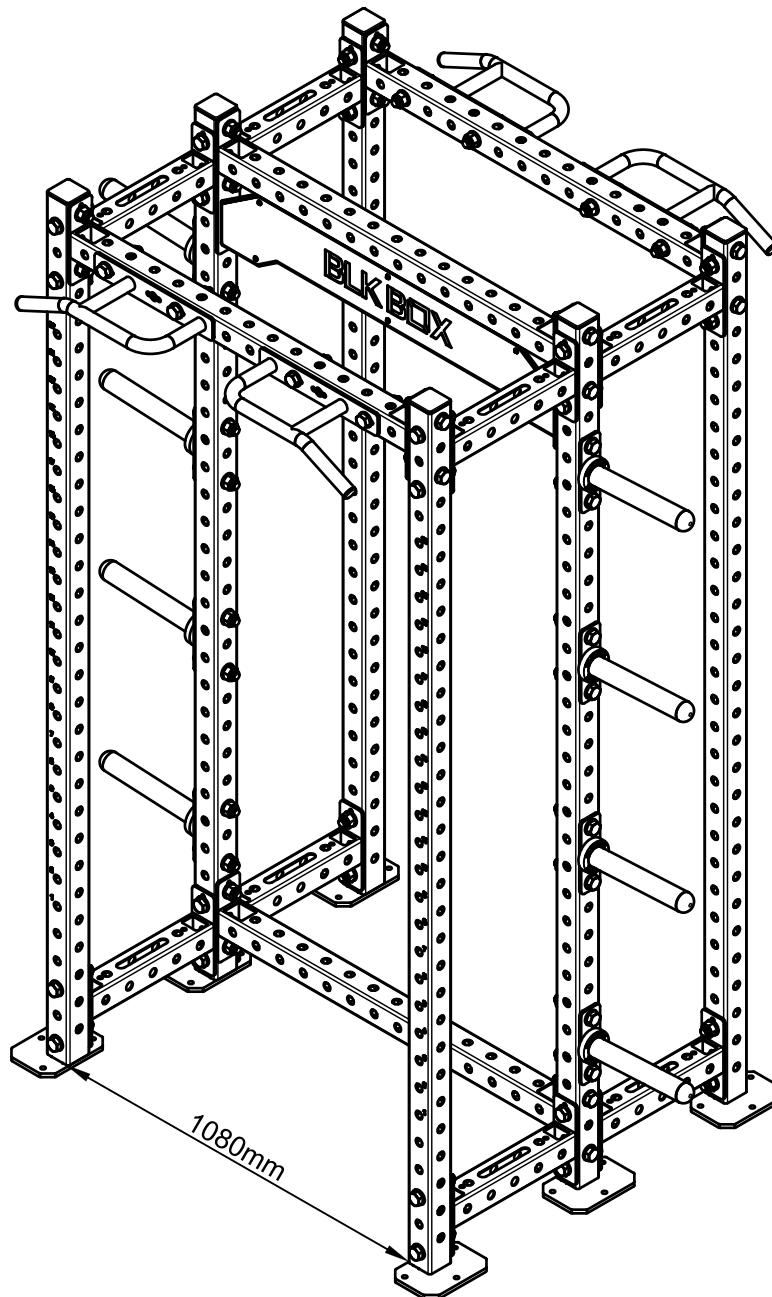

Assembly

Hardware	
#	Qty.
M	18
N	18

6

1

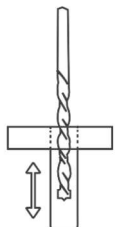

Drill 10mm hole through foot plate hole 90mm deep.

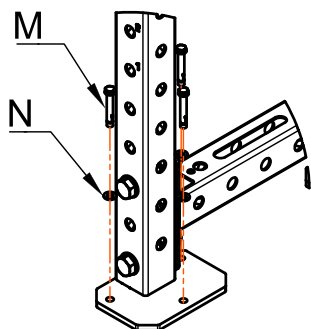

2

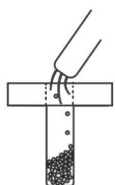

Vacuum out dust from drilled hole.

3

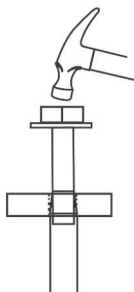

Hammer sleeve anchor into hole.

4

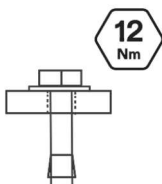

Tighten sleeve anchor to specified torque using 13mm spanner.



13mm Spanner x1

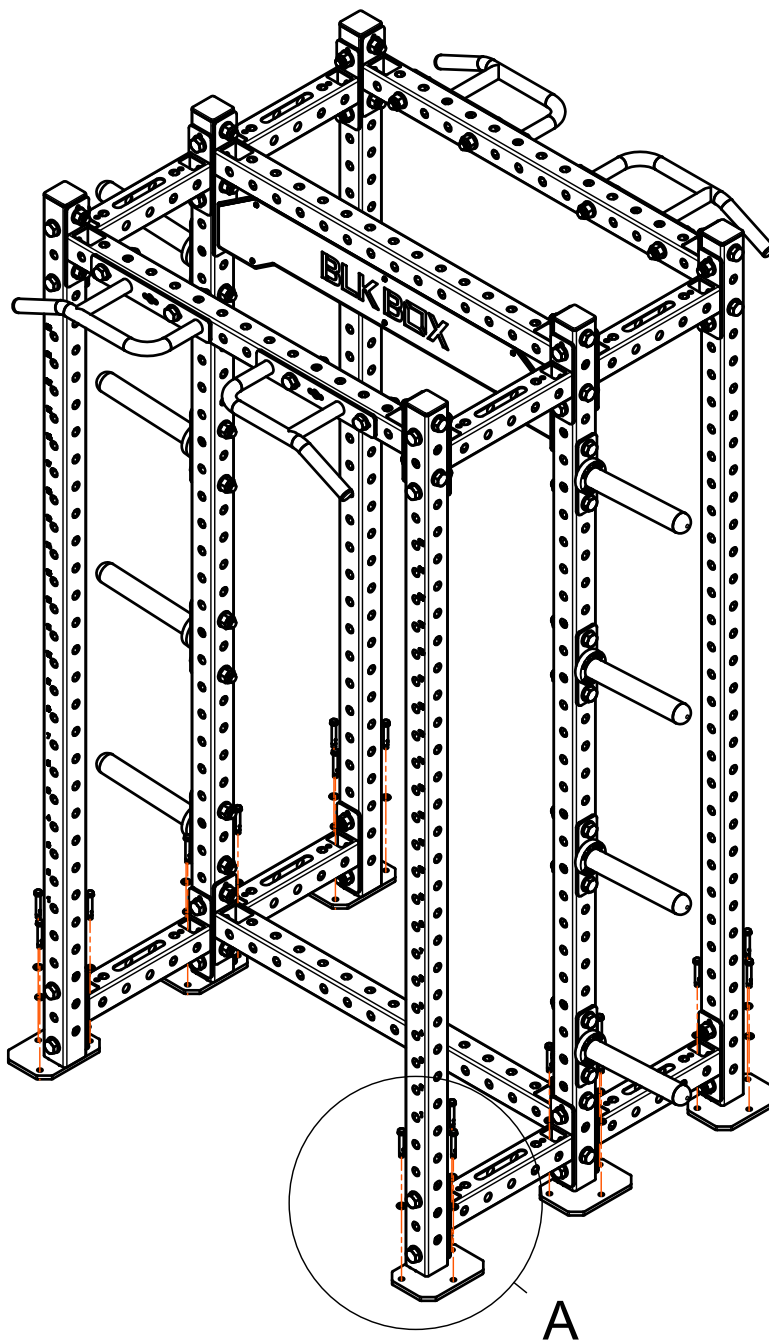

Assembly

Parts	
#	Qty.
1	2

7

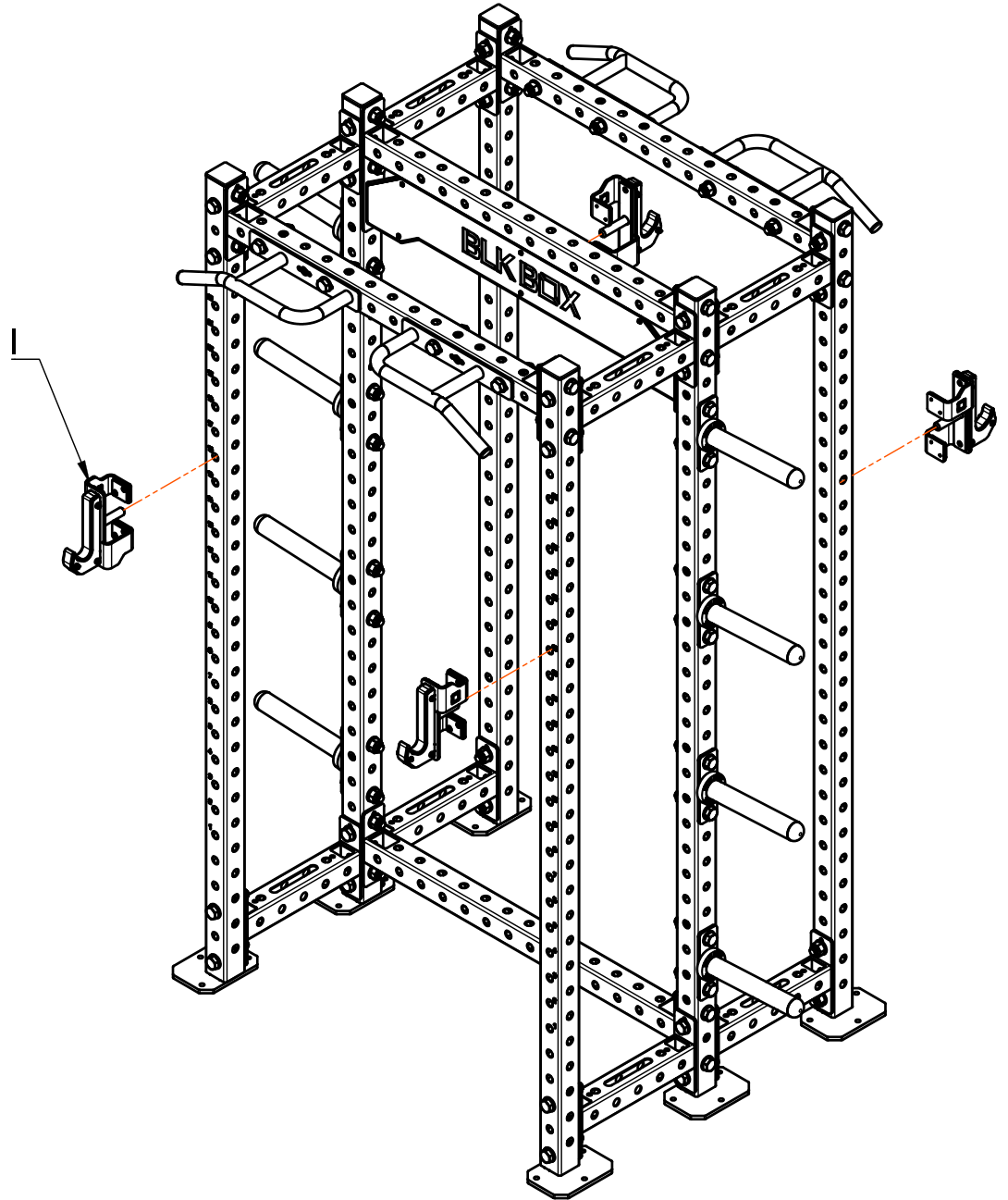
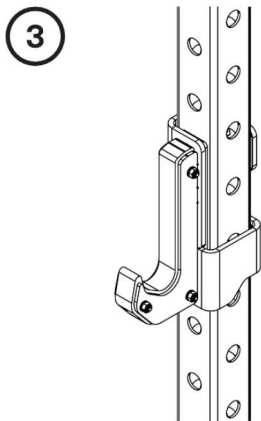
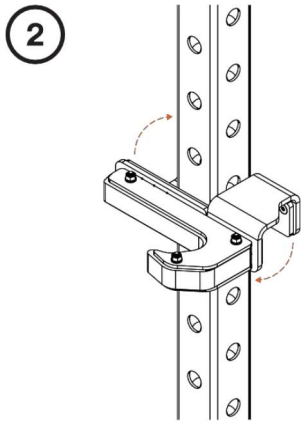
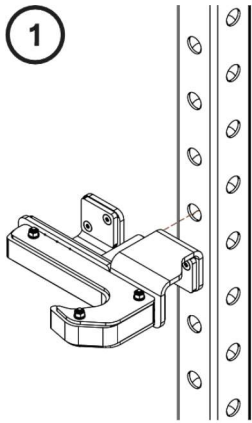

Care and Maintenance

Inspection Checklist

Category	Check	Frequency
Floor Anchoring/Stability	Verify equipment is stable, level, and securely anchored to floor/wall	Monthly
Metalwork	Inspect for cracks, bends, sharp edges, corrosion, or other signs of damage	Monthly
Hardware	Ensure nuts, bolts, and washers are secure, undamaged, and tightened correctly	Monthly
Cables & Pulleys	Inspect cables for fraying, kinks, or broken strands; check pulleys rotate smoothly	Daily
Moving Parts & Bearings	Check joints, hinges, and bearings for excessive play, noise, or lack of lubrication	Monthly
Attachments/Accessories	Inspect all attachments and accessories for wear or damage	Monthly
Nylon & Plastic Parts	Inspect end caps, covers, and protective guards for cracks, deformation, or looseness	Monthly
Rubber Components	Inspect grips, feet, and protective bumpers for cracks, hardening, or excessive wear	Monthly
Upholstery	Check pads/covers for tears, punctures, loose stitching, or worn areas	Monthly
Warning/Safety Labels	Confirm labels are present, secure, legible, and not obscured or damaged	Monthly

If any component of the equipment is found to be damaged, worn, or defective, discontinue use immediately. Do not operate the equipment until all necessary repairs or replacements have been completed. Always use only genuine replacement parts supplied by BLK BOX. The use of non-approved parts may compromise safety and performance. Continued use of defective or improperly repaired equipment may result in injury or further damage.

Maintenance Checklist

The safety level of equipment can be maintained only if it is examined regularly for damage and wear.

Category	Check	Frequency
Frame & Structure	Wipe clean using a soft cloth and dry	As needed
Guide Rods (Cleaning)	Wipe clean using a soft lint-free cloth and dry	Weekly
Guide Rods (Lubrication)	Guide rods should be lubricated with a silicon based lubricant using a cotton cloth	As needed
Upholstery	Wipe clean using a soft cloth and dry	As needed
Warning/Safety Labels	Wipe labels to keep them clean and legible	As needed

Cleaning Notes

When cleaning, use a diluted pH neutral, solvent free antibacterial surface cleaner. Avoid any harsh chemicals, alcohol-based cleaners, or abrasive cleaning tools.

Only cleaning products recommended by BLK BOX should be used on this equipment. The client is responsible for ensuring the equipment is maintained correctly, including regular cleaning, lubrication, and care in line with BLK BOX guidelines. Use of unapproved products or improper maintenance may damage the equipment and void any warranties.

Further Information

Installation Notes

Our equipment is intended for indoor use only (unless otherwise specified) and for commercial or domestic use (Class SH). The below statements must be adhered to as and when applicable.

1. Stable and level surface: BLK BOX equipment must be installed on a flat, stable and horizontal base that has been properly levelled.
2. Securing equipment: BLK BOX recommend that all **stationary** strength equipment should be secured to the floor to stabilise equipment and eliminate rocking or tipping over. This must be performed by a licensed contractor.

Proper Usage

All warnings and instructions should be read and proper instruction obtained prior to use. Ensure to use this equipment for its intended purpose **ONLY**.

1. Keep children under the age of 14 away from this equipment. Teenagers must be supervised at all times while using this equipment.
2. This equipment is not intended for use by persons with reduced physical, sensory or mental capabilities, or lack of experience and knowledge, unless they have been given supervision or instruction concerning use of the equipment by a person responsible for their safety.
3. Inspect the equipment before use. **DO NOT** use equipment if it appears damaged or inoperable.
4. Exceeding the maximum training weight of the equipment is strictly prohibited.
5. Never try to exceed personal strength levels. Always use a spotter if using free weights.
6. Ensure any squat type exercises or similar movements are performed inside of the rack using central uprights.
7. Balance the weight applied to this equipment and/or any barbell. Retention devices must be used to secure weight plates.
8. Injuries to health may result from incorrect or excessive training. Cease exercise if you feel faint or dizzy. Obtain a medical exam before beginning an exercise program.
9. Keep body, clothing, hair, and fitness accessories free and clear of all moving parts.
10. Set any bar catchers/supports to the appropriate height for the exercise being performed. For squat-type movements, these should be set to a minimum of 710mm from the ground, as marked on the upright. If bar catchers/supports are removed for any reason, ensure they are attached again before leaving the area.
11. When adjusting any adjustable mechanism make certain that the adjustable mechanism is fully engaged prior to use to prevent unintended motion.
12. Use only with Olympic sized bumper plates and compatible weight retention devices. Where provided, store bumper plates on the designated utility pegs after use.
13. If equipment is **NOT** secured to floor: **NEVER** allow resistance straps, ropes or other means to be attached to this equipment, as this may result in serious injury. **NEVER** use this equipment for support during stretching, as this may result in serious injury.

Important Safety Information

It is the sole responsibility of the purchaser of BLK BOX products to instruct all individuals, whether they are the end user or supervising personnel on proper usage of the equipment. It is recommended that all users of BLK BOX exercise equipment be informed of the following information prior to its use. Do not use any equipment in any way other than designed or intended by the manufacturer. It is imperative that BLK BOX equipment be used properly to avoid injury.

Additional Notes

This equipment should only be installed and used in supervised areas where access and control is specifically regulated by the owner. It is up to the owner to determine who is allowed access to this training equipment and provide the user with all warnings and instructions. The owner should consider user's: degree of reliability, age, experience, etc. This training equipment meets industry standards for stability when used for its intended purpose in accordance with the instructions provided by the manufacturer.

Terms and Conditions

Warranty Terms

All BLK BOX branded equipment is covered by a limited 12-month warranty.

All metal work or manufactured items are covered by a lifetime structural guarantee.

Warranty terms do not extend to damage arising from improper use, normal wear and tear, improper maintenance, alteration, misuse, negligence, or otherwise not arising from defects of material or workmanship.

Returns

All goods must be in a new resalable condition the product must not be defective or used by the client and contain all original parts and accessories. This must include all original packaging and tags.

We may decline a return or exchange during the process if the items returned have been damaged or any of the above stipulations have not been met.

We will only refund a delivery charge when there has been a direct error in the delivery process. Delivery charges will not be refunded for late deliveries within a reasonable timeframe.

Any items returned for refund or exchange without original documentation or without return form will be rejected.

Please clearly state on the invoice/return form the reason for return or exchange and whether you require a refund or exchange.

Products can be exchanged for a different size or colour of the same product, provided that the preferred size or colour is available in stock.

This option is available within 30 days of the delivery and item must not be used in that period. If the preferred size or colour is not available, or you want a different product, please return the unwanted product, and place a new order.

Returns will be processed within 5 business days of arrival at our warehouse.

It sometimes takes up to 14 days to appear in your bank statement as bank processes vary by the institutions.

Please note that refunds will be issued to the original method of payment.

For our full list of Terms & Conditions, please visit <https://www.blkboxfitness.com/pages/terms>.

Customer Service

For any queries, advice or missing components please contact us on:



info@blkboxfitness.com



BLK BOX



+44 (0) 28 9045 4123



@blkboxfitness



Manufacturer Information
BLK BOX Fitness Ltd.
4 Cloughfern Avenue, Newtownabbey,
BT37 0UB, Northern Ireland



www.blkboxfitness.com